

### GENERAL CHARACTERISTICS

Nominal Overall Diameter .....	306	mm
Nominal Voice Coil Diameter .....	38	mm
Magnet Weight .....	640	g
Flux Density .....	1.16	T

### THIELE-SMALL PARAMETERS

Voice Coil DC Resistance .....	$R_E$	5.00	Ω
Resonance Frequency .....	$f_s$	79.0	Hz
Mechanical Q Factor .....	$Q_{MS}$	7.98	
Electrical Q Factor .....	$Q_{ES}$	0.96	
Total Q Factor .....	$Q_{TS}$	0.85	
Mechanical Moving Mass .....	$M_{MS}$	30.5	g
Mechanical Compliance .....	$C_{MS}$	135.0	μm/N
Force Factor .....	$B \times l$	8.98	Wb/m
Equivalent Acoustic Volume .....	$V_{AS}$	45.5	lt.
Maximum Linear Displacement ...	$X_{MAX}$	1.50	mm
Reference Efficiency .....	$\eta_0$	2.24	%
Diaphragm Area .....	$S_D$	490.8	cm <sup>2</sup>
Losses Electrical Resistance .....	$R_{ES}$	43.0	Ω
Voice Coil Inductance @ 1kHz ....	$L_E$	0.54	mH

### CONSTRUCTIVE CHARACTERISTICS

Magnet .....	Ferrite
Voice Coil Winding .....	Copper
Voice Coil Former .....	Epotex
Cone .....	Paper
Surround .....	Integrated Paper
Dust Dome .....	Non Treated Cloth
Basket .....	Pressed Sheet Steel

### ELECTRICAL CHARACTERISTICS

Nominal Impedance .....	8	Ω
Rated Power (DIN 45573 - IEC 268.5) .....	70	W
Musical Power (DIN 45500) .....	140	W
Sensitivity @ 1 W, 1 m .....	97.5	dB

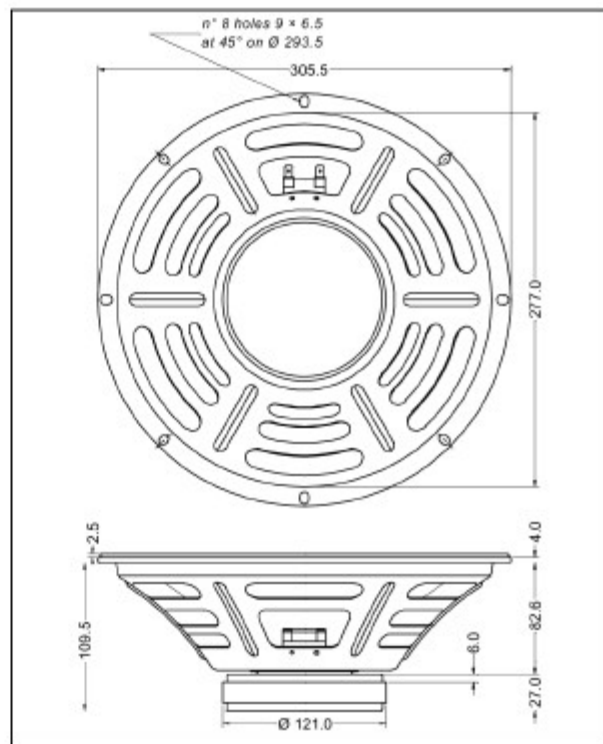

Frequency Response on IEC Baffle (DIN 45575) @ 1 W, 1 m - Impedance

